

APD HV_Pro Series: HV_Pro20S Datasheet

Version: 1.2

Drawings

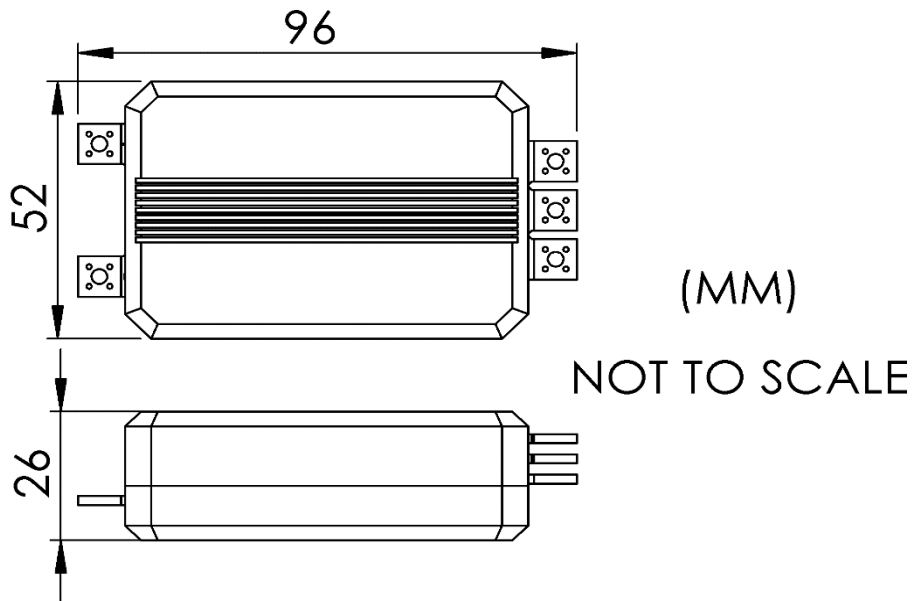

Specification

Peak Power Rating (kW)	30	Weight (No cables) (g)	260
Continuous Current (A)	300	Dimensions (mm)	96 × 52 × 26
Continuous Rating Duration (s)	180	Input Signal PWM Frequency	Up to 500Hz
Burst Current (A)	450	Input PWM Frequency Pulse Width (ms)	1000µs to 2000µs (Adjustable)
Burst Rating Duration (s)	5	Motor De-sync Protection	YES
Max Voltage (V)	85	Auto Motor PWM-Freq	YES
Max No. of LiPo Cells	20S	Regenerative Braking	YES
Min Voltage (V)	15	Max Regen Current (A)	30 (10% max set current)
Min No. of LiPo Cells	5S	Max Regen Voltage	110% Power on Voltage
Max ERPM	1,000,000	Auto Timing Advance	YES
Input Resolution	12 bit (0.02%)	Stall Protection	YES
		Configurator Tool	YES
Max Operating Temperature (°C) (50% current limit start point)	115	Data Logging (Black Box)	YES
Recommended Airflow to achieve max power ratings (m/s)	10	Bi-Directional Control	YES
Decoupling Capacitor	Not Included	Micro USB Firmware Flashing	YES

CAD Files

<https://docs.powerdrives.net/downloads/cad-downloads>

Quick Start Guide

https://docs.powerdrives.net/products/hv_pro